



Efficient Mixing and Agitation

Side mounted agitators Type ALS

ESE00218EN 0901

Applications

The Alfa Laval side mounted agitator offers mixing solutions to meet any requirements in food, dairy, beverage, pharmaceutical, biotechnology or cosmetic applications.

Type ALS agitators can be dimensioned for several applications for both atmospheric and pressurised tanks and furthermore for use in sterile/aseptic applications. The correct sizing of the agitators ensures an optimised solution offering low energy consumption and configuration to meet specific design requirements. Examples are listed below:

| Application | Typical examples |
|-------------------------------|--|
| Maintain media homogeneous | Milk storage tanks, mixed product tanks, etc. |
| Mixing & Solutions (dissolve) | Fluid and fluid mixing, i.e. drinking yoghurt and fruit mix tanks, flavoured milk mix tanks, syrup mix tanks, etc. |
| Solid Dispersion | Powder + fluid mix tanks, etc. |
| Suspension | Fluids with particles, i.e. juice tanks |
| Heat transmission | Circulation of media in tanks with dimple jacket (cooling or heating) |

Standard design

The Alfa Laval range of side mounted propeller agitators is designed to meet almost every customer requirement. Due to their modular build, the agitators can be designed for every kind of application within the sanitary industry. The modular construction is designed with the aim to meet both European and American standards and regulations, such as EHEDG, USDA, FDA, 3A etc. Please note that Alfa Laval also deliver other agitator solutions:

- Type ALT, top mounted agitators
- Type ALTB, top mounted agitators with bottom steady bearing
- Type ALB, bottom mounted agitators

To read more about these agitator solutions, please see separate PD Sheets.



Configurable design

Type ALS agitators is a fully configurable design and the configuration can be divided into the following elements:

- Drives (drive + shaft support + shaft diameter)
- Seal arrangements (oil trap + shaft seal type)
- Shaft (length)
- Energy Saving Foils (propeller type + surface finish)
- Options

Each element has a broad range of different characteristics which makes it possible to size the agitator for all applications and requirements.

Advantageous and profitable design









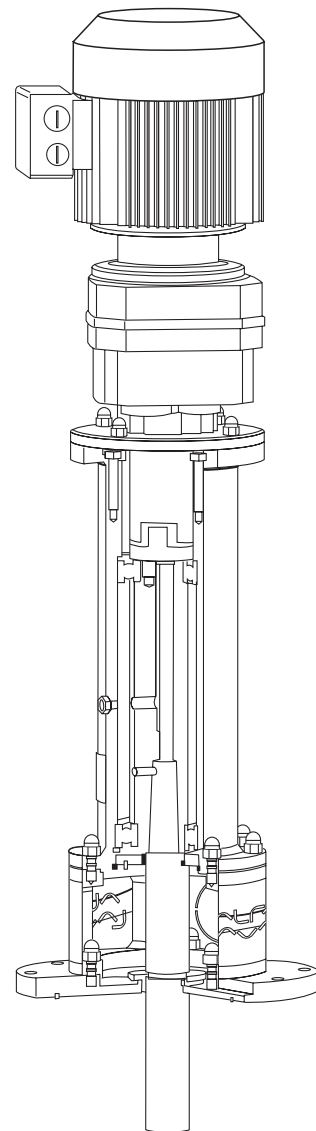
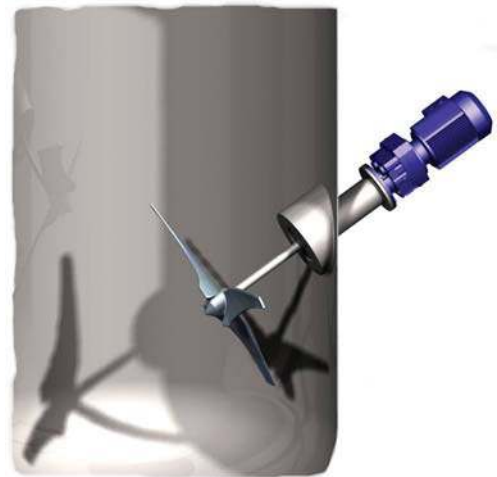

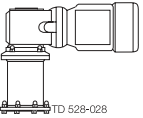
Each configuration offers a number of advantages, which are shown in the examples below:

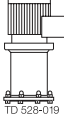
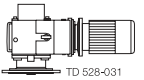
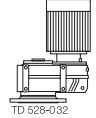
| Operation features | Due to |
|--------------------------|--|
| Low energy consumption | the wide range of high efficiency propellers and drive units makes it possible to design for low operational costs |
| Gentle product treatment | the wide range of high efficiency propellers makes it possible to design for low shear operation |

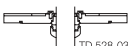
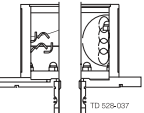
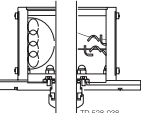
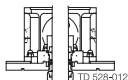
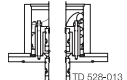
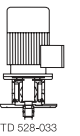
| Sanitary features | Due to |
|---|--|
| Easy external cleaning | stainless steel bearing frame design with O-ring seal (for wash down) |
| Connections inside the tank (risk zones) can be avoided | bearing frame drives with drive shaft and special internal shaft connection without having a flange coupling inside the tank |
| Good drip off properties | no plane surfaces or grooves on internal parts |
| Easy cleaning | no interior shadow sides between the blades and smooth surfaces |

| Maintenance features | Due to |
|--|---|
| All service (replacement of wear parts such as shaft seals, bearings etc.) can be done from out side of the tank | bearing frame drives with detachable shaft which can be dismantled from outside of the tank |
| Easy dismantling | use of spider type coupling and stainless steel parts (no corrosion) |

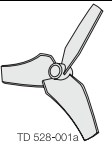

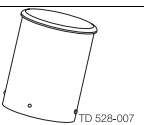
| Type ALS | Configuration | | | | | | Side mounted agitators |
|---|---|---|--|--|---|---|--|
| Drives Bearing frame size = xx Shaft diameter = yy (not used if xx = yy) Description (power, speed and shaft diameter depending on application) |  TD 528-028 -ME-GR-Bxx(yy) Stainless steel bearing frame and right angle gearbox |  TD 528-029 -ME-GC-Bxx(yy) Stainless steel bearing frame and coaxial gearbox |  TD 528-019 -ME-Bxx(yy) Stainless steel bearing frame and direct motor drive |  TD 528-031 -ME-GR-yy Right angle gearbox, shaft mounted in hollow shaft of gearbox |  TD 528-032 -ME-GP-yy Parallel shaft gearbox, shaft mounted in hollow shaft of gearbox | | |
| Seal arrangements Description (lower flange and seal material depending on application) |  TD 528-035 F-S1- Seal flange with O-ring seal against tank flange, drain, oil trap (only geared versions) and shaft seal: single mechanical bellow seal |  TD 528-036 F-S2- Seal flange with O-ring seal against tank flange, drain, oil trap (only geared versions) and shaft seal: single mechanical non-bellow seal |  TD 528-037 LF-S1- Lantern (spacer), seal flange with O-ring seal against tank flange, drain, oil trap (only geared versions) and shaft seal: single mechanical bellow seal |  TD 528-038 LF-S2- Lantern (spacer), seal flange with O-ring seal against tank flange, drain, oil trap (only geared versions) and shaft seal: single mechanical non-bellow seal |  TD 528-012 LF-D- Lantern (spacer), seal flange with O-ring seal against tank flange, drain, oil trap and shaft seal: double mechanical seal for high pressure applications and aseptic use |  TD 528-013 LF-DT- Lantern (spacer), seal flange with O-ring seal against tank flange, drain, oil trap and shaft seal: double mechanical seal (tandem) for low pressure applications |  TD 528-033 -ME-yyLF-S1- Direct motor drive, shaft connected directly to motor, lantern (spacer), seal flange with O-ring seal against tank flange, drain and shaft seal: single mechanical bellow seal |
| Shaft Length = IIII Description (material depending on application) |  TD 528-034 -SIII- SS shaft, length according to application | | | | | | |
| Energy Saving Foils Diameter =vvv (125 mm to 1900 mm) |  TD 528-001 -PvvvD3P 3-bladed propeller, finish: polished Standard: Ra < 0.8 µm |  TD 528-001 -PvvvD3PE 3-bladed propeller, finish: polished and electro polished Standard: Ra < 0.8 µm |  TD 528-001a -PvvvD3G 3-bladed propeller, finish: shot peened | | | | |
| Optional Description |  TD 528-005 Welding flange Incl. mounting pin bolts and nuts |  TD 528-006 Blind flange Incl. O-ring seal |  TD 528-007 Cover for Motor / gear motor) Stainless steel cover - comes in different shapes according to drive type | S Spare part kit Standard spare part kit | | | |

Motor

Motor size and speed as required for duty.
As standard with IEC motor IP55, other types on request.
As standard painted RAL5010.

Voltage and frequency

As standard for 3x380 to 420V, 50Hz - 3x440V to 480V, 60Hz
All motor voltages and frequencies are available.

Gears

Different gear types available according to configuration.
As standard filled with normal synthetic or mineral oil, optional: Food approved oil.
As standard painted RAL5010.

Materials

List the range of materials available for wetted parts:

| | |
|---|--|
| Steel parts: | AISI 316L (standard) AISI 304 AISI 904L SAF 2205 Other materials on request. |
| Seal rubber parts (O-rings or bellows): | EPDM FPM/FEP (only for stationary o-rings) FPM Other materials on request. |
| Mechanical seal parts: | Carbon Carbon (FDA) Silicon carbide |

Specific selection of materials will depend on the actual configuration selected.

Material Certificate - optional

3.1 Material certificates/FDA conformity statement according to 21 CFR177 on steel/elastomer parts in contact with media

ATEX - optional

Agitators can be delivered approved for use in an ATEX environment with declaration of conformity according to directive 94/9/EC, approved according to ATEX categories:

| | |
|---------------|-----------------------------------|
| In tank: | II1GDcTX, II2GDcTX or II3GDcTX |
| Outside tank: | II2GDcTX or II3GDcTX |

NOTE: Not all configurations can be delivered according to ATEX directive 94/9/EC.

Dimensions

Propeller standard diameter range: Ø125 mm til 1900 mm.
Specific dimensions on the drive unit and propeller(s) will depend on the actual configuration selected.

Enquiries

The following information is required to ensure correct sizing and configuration for ordering:
For budget pricing, use the following enquiry handling form from Alfa Laval (electronic version): "Simple inquiry, agitator".
For detailed quotation use the following enquiry handling form from Alfa Laval (electronic version): "Advanced enquiry, agitator".

ESE00218EN 0901

The information contained herein is correct at the time of issue, but may be subject to change without prior notice.

How to contact Alfa Laval

Contact details for all countries are continually updated on our website. Please visit www.alfalaval.com to access the information direct.